

MONACO COMPONENTS, INC.

BUILT-IN DRIVE STYLE FLANGE MOUNTING

**3000
series**

- Selectable combinations of three tones.
- A single tone may be fixed at the factory.
- Very high sound output.

MODEL	MPA-3326	MPA-3328	MPA-3330	MPA-3332
FREQUENCY *	2800 HZ ± 500 Hz			
DRIVING CIRCUIT	BUILT IN			
OPERATING VOLTAGE	16 - 28 V			
RATED VOLTAGE	24 V			
SOUND PRESSURE *	109 dB @ 100 cm			
CURRENT CONSUMPTION *	85 mA			
TONE	SELECTABLE: CONTINUOUS, PULSE, SIREN	CONTINUOUS	SIREN	PULSE
CONNECTION STYLE	FLANGE / LEADS			
OPERATING TEMPERATURE	-20° to +70° C			

* VALUES AT RATED VOLTAGE

MPA-3326
MPA-3328
MPA-3330
MPA-3332

COLOR : IVORY

TONE SELECT:
G-Y SIREN
G-O PULSE
N/C CONTINUOUS

ALL DIMENSIONS IN mm

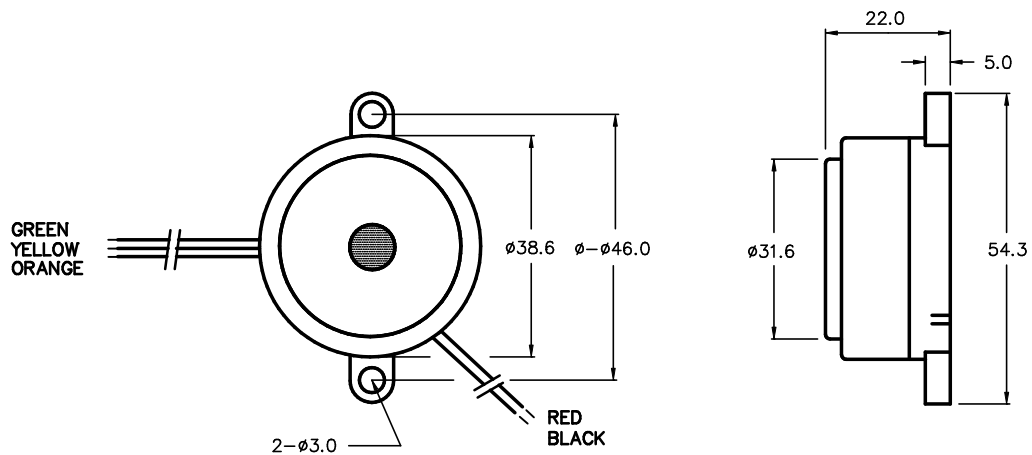

SPECIFICATIONS SUBJECT TO CHANGE WITHOUT NOTIFICATION / MODELS SHOWN SUBJECT TO LIMITED WARRANTY

SALES OFFICE (516)-767-6644

CORPORATE OFFICE

P.O. Box 575, Scotch Plains, NJ. 07076

Phone: (908)-322-2977 Fax: (908)-322-2358

E-mail: info@monacocomponents.com

www.monacocomponents.com